

X-SERIES

2.4G · 6-AXIS
HEADLESS MODE
6-Axis Gyro Quad-copter 3D ROLL · ONE KEY RETURN



INSTRUCTION MANUAL

Thank you for purchasing this product. Please read this manual carefully before use and retain it for future reference.

Technical parameter of the model

Fuselage Length: 505mm Gross Weight: about 420g Motor: 050 motor
Overall height: 180mm Battery: Li-polymer 7.4V
Main Rotor Propeller: 210mm Charging Time: about 2.5 hours

Introduction

- Quad-rotor design insures more stable and powerful performance and make all kinds of 3D action more easier.
- Headless mode and one key return are available.
- New designed structure makes assembly and maintenance easier.
- Adopting 2.4G auto connection technology, scores of model can be played at the same time.
- Equipped with the newest 6-axis gyro control system, this model has the characteristics of stable flight and easy operation.
- Full charged battery can support 10 minutes steady flight.

Product/spare parts included in this packaging

Description	QTY (pc)	Description	QTY (pc)
Model	1	Propeller	4
Remote Controller	1	Landing gear	2
Manual	1	Protecting Guard	4
Screwdriver	1	Charger	1
Screw	12		

Safety Guidelines

- This product is not a toy. It is not applicable for children who are under 14 years old.
- Please read this instruction manual carefully before playing and operate the product according to the manual.
- The users are in full charge of proper operating the model. The manufacturer and dealers disclaim all responsibility for the damage caused by misuse.
- Keep the small accessories away from the kids to avoid accident.
- Keep batteries away from fire or high temperature environment.
- When flying the model, keep it 1~2 meters away from user or others to avoid injury due to collision.
- Not to decompose or modify the product which may cause malfunction or accident.
- Fly the model within your eye vision for easy and safety control.
- Need adult supervision when this model is being played by children.
- Only batteries of the same or equivalent type as recommended are to be used.
- Insert batteries with correct polarity.
- Non rechargeable batteries are not to be charged; the transmitter need 3 X AA batteries for work.
- Do not mix old and new batteries.
- Do not mix alkaline, standard (carbon-zinc), or rechargeable (nickel-cadmium) batteries.
- Rechargeable batteries are to be removed from the toy before being charged.
- Rechargeable batteries are only to be charged under adult supervision;
- Exhausted batteries are to be removed from the toy.
- The supply terminals are not to be short-circuited.
- The USB charging line to be used with the product should be regularly examined for potential hazard, such as damage to the cable or cord, plug, enclosure of other parts and that in the event of such damage, the product must not be used until that damage had been properly removed.

The LCD remote controller

Main features of the remote controller

- Adopt microcomputer control remote controller system and 2.4G auto connection technology, scores of copters can be played at the same time without any interference.
- Control the function of upward, downward, forward, backward, leftward, rightward, turn left, turn right and 3D flips & roll of the copter.
- Throttle control stick can be freely switched according to player's habit.

Sketch and function switches of the remote controller

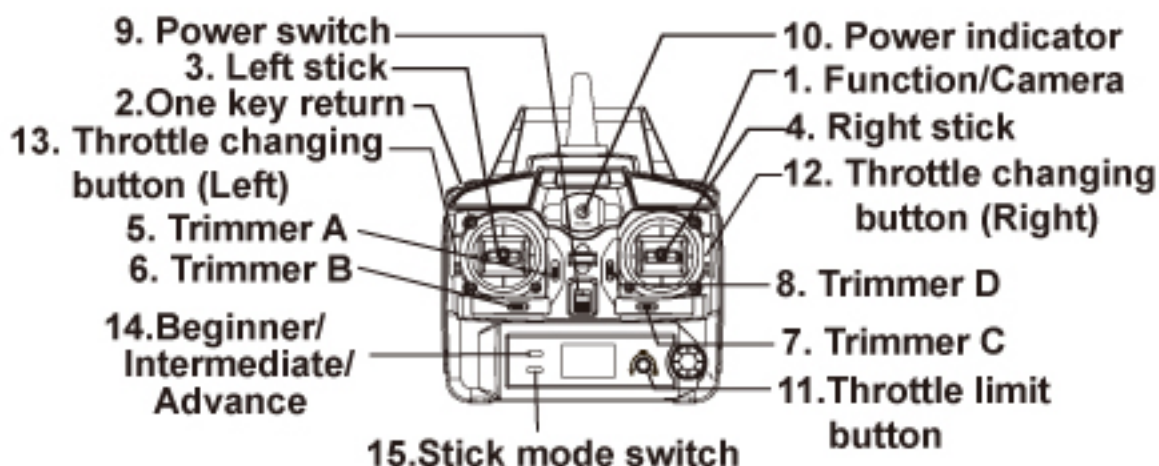

Remote Controller(Transmitter)

No.	Function switch	Function description
1	Function/ Camera	One key roll button: When the model is flying, press this button, the model will roll forward once. Camera button: When the model is powered on and mounted with camera, this is the camera on-off button. Headless mode on-off button: Press this button for about 2 seconds, the remote control will send out 2 beep sounds and letters "stick mod" will be flashing on the LCD screen, the indicator light of the model turns from constant "on" to "flashing", then, the model is in the headless mode. Press this button again for about 2 seconds, the remote control will send out 2 beep sounds and "stick mod" keeps constant "on", indicator light of the model turns from flashing to constant "on", then, the model exit headless mode.

No.	Function switch	Function description
2	One key return	<p>When the model is flying in headless mode, press one key return button, the model will fly towards player.</p> <p>Press the one key return button again or operate the forward /backward control stick, the model will exit the one key return function.</p>
3	Left stick	<p>STICK MODE 2:upward/downward,turn left/turn right;</p> <p>STICK MODE 4:upward/downward,leftward/rightward.</p> <p>STICK MODE 1:forward/backward,turn left/turn right;</p> <p>STICK MODE 3:forward/backward,leftward/rightward.</p>
4	Right stick	<p>STICK MODE 1: upward/downward,leftward/rightward;</p> <p>STICK MODE 3: upward/downward, turn left/turn right;</p> <p>STICK MODE 2: forward/backward,leftward/rightward;</p> <p>STICK MODE 4: forward/backward,turn left/turn right.</p>
5	Trimmer A	<p>In stick Mode 2 and 4, this button is null.</p> <p>In stick Mode 1 and 3, it helps to tune the model's forward and backward flight.</p>
6	Trimmer B	<p>In stick Mode 3 and 4, it helps to tune the model's sideward flight.</p> <p>In stick Mode 1 and 2,it helps to tune the model's left and right direction turning speed.</p>
7	Trimmer C	<p>In stick Mode 3 and 4, it helps to tune the model's left and right direction turning speed.</p> <p>In stick Mode 1 and 2,it helps to tune the model's sideward flight.</p>
8	Trimmer D	<p>In stick Mode 1 and 3, this button is null.</p> <p>In stick Mode 2 and 4, it helps to tune the model's forward and backward flight.</p>
9	Power switch	<p>It controls the power source of the transmitter.</p> <p>Slide the power switch to the "ON" position, the transmitter is powered on; slide the power switch to the "OFF" position, the transmitter is powered off.</p>

No.	Function switch	Function description
10	Power indicator	<p>The indicator light keeps blinking slowly: the transmitter is not activated.</p> <p>The indicator light keeps flashing rapidly: the transmitter is sending out connectional signal to the model.</p> <p>The indicator light keeps on without blinking: the transmitter is ready for controlling the flight.</p>
11	Throttle limit button	The throttle of the model can be adjusted by this button, player can use this button to increase or decrease the model's upward/downward speed.
12/13	Throttle changing button	Slide down or slide up the 2 buttons at the same time to select the throttle control stick.
14	Beginner/Intermediate/Advance	There are 3 flight modes of the model: low speed, medium speed and high speed.
15	Aileron/rudder changing button	Also named Stick Mode changing button. Press this button to change the control stick mode.

How to install the battery of remote controller



Pic.1

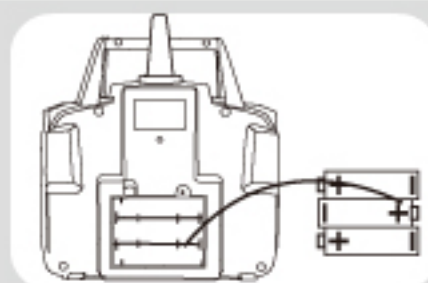

Pic.2



Pic.3

How to remove and insert batteries.

1. Unscrew counter clockwise to open the battery compartment cover. (Pic.1)
2. Install 3 X AA batteries into the battery compartment according to the given polarity. (Pic. 2)
3. Screw clockwise to close the battery compartment. (Pic. 3)

Select throttle control stick

There is 1 throttle button on either side of the remote controller.

1. Slide both of the 2 buttons to "R", the right stick is the throttle control stick.
2. Slide both of the 2 buttons to "L", the left stick is the throttle control stick.
3. Both of the 2 buttons should be either on the position of "R" or "L", otherwise, the remote controller can not be activated.

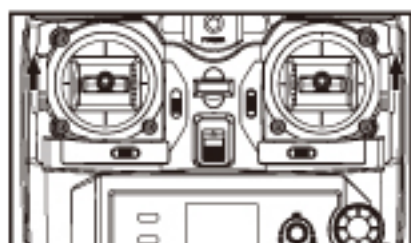

Pic.4

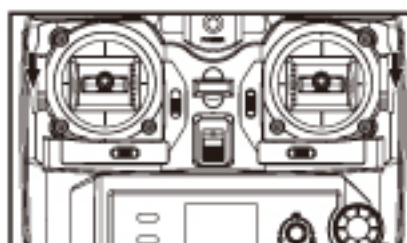

Pic.5

Stick mode selection

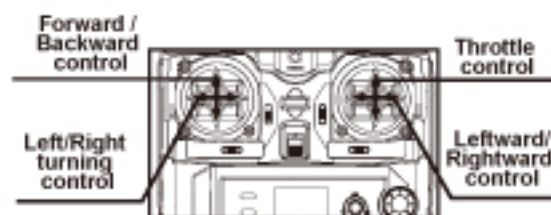

Pic.6

STICK MODE : 1

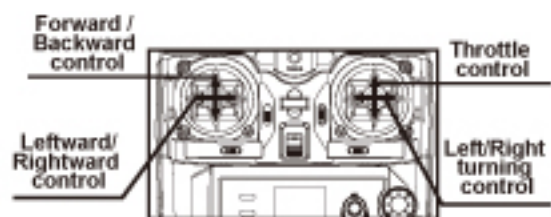

Pic.8

STICK MODE : 3

When the right stick controls the throttle, press the AILE/ RUDD button to select the Mode(Mode 1 or Mode 3).

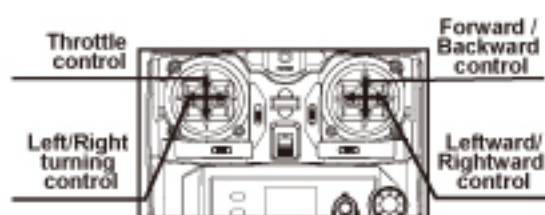

Pic.7

STICK MODE : 2



Pic.9

STICK MODE : 4

When the left stick controls the throttle, press the AILE/ RUDD button to select the Mode(Mode 2 or Mode 4).

Flight mode selection

There are 3 flight modes available: low speed, medium speed and high speed.

Player can select the flight speed by pressing the flight mode button.



Pic.10



Pic.11



Pic.12

The model

Major parts of the model

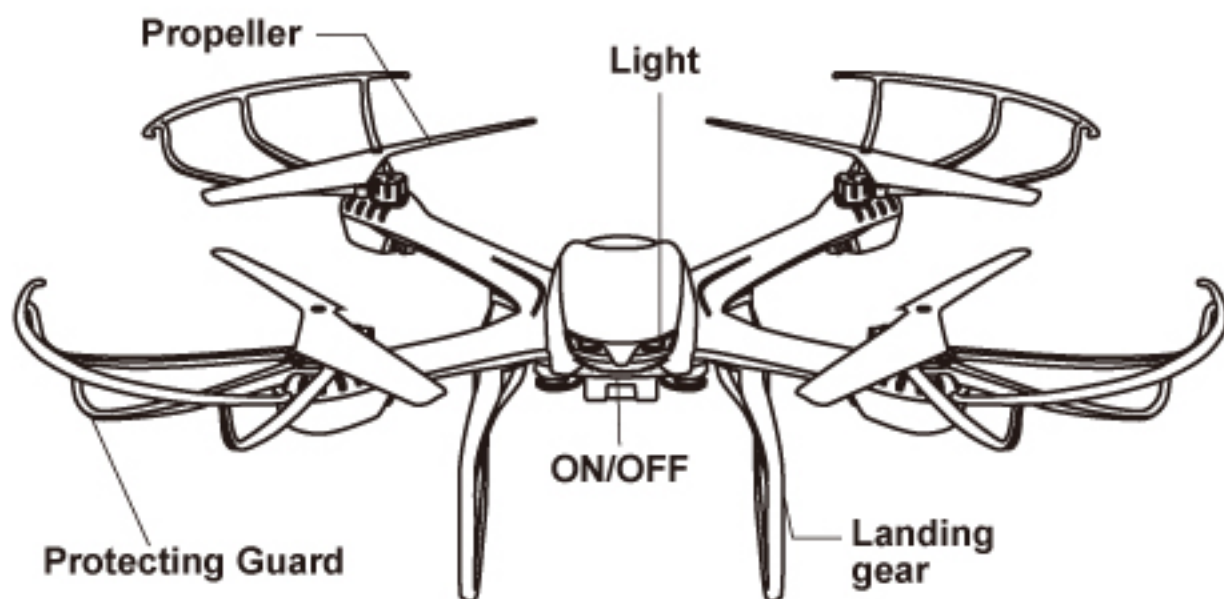

Propeller blade installation



Pic.13



Pic.14



Pic.15

1. Before installation, please distinguish clockwise rotor blades and the counter-clockwise rotor blades. Make sure that the clockwise rotor blades are to be fixed on the clockwise motors and the counter-clockwise rotor blades are to be fixed on the counter-clockwise motors (Pic. 13).
2. When installing the rotor blade, push up the gear component to make the main shaft protrude, and then insert the main shaft into the rotor blade fully (Pic.14).
3. Use screw to lock the rotor blade by turning clockwise (Pic.15).

Protecting Guard and Landing Gear installation



Pic.16



Pic.17



Pic.18



Pic.19

1. There are 3 interfaces on each motor cabinet. Insert the frame plugs into the interfaces and fix it. (Pic.16)
2. Fix the protection frame by screwing clockwise. (Pic.17)
3. There are 4 interfaces at the bottom of the model, insert the landing gear plugs into the interfaces and fix it.(Pic.18)
4. Fix the Landing gear by screwing clockwise.(Pic.19)

How to change new battery for the model

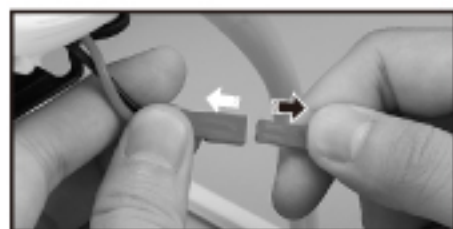

Pic.20



Pic.21

1. Unplug the battery wire from the power wire plug of the model and take out the battery.(Pic.20)
2. Plug the new battery wire into the power wire plug of the model and insert the battery into the battery compartment.(Pic.21)

How to charge the model

Turn off the model, unplug the battery cable from the power wire plug and take out the battery. Insert the charger to the power outlet, the indicator light will be green; connect the battery cable with the charger wire plug, the indicator will be red when charging is proceeding; once the battery is full charged, the indicator light will be green. Full charging takes about 2.5 hours.



Pic.22

NOTE:Battery should be full charged before storing.

Preparation for flight

The remote control

- Recheck the playground; be sure that it is free from crowd, animals and other barrier.
- Slide both of the 2 throttle control buttons to "R" or to "L" position to choose the throttle control stick.
- Slide down the throttle control stick to the bottom.
- Turn on the remote controller and the power light will blink slowly. Then slide the throttle control stick up to the top; the power light blinks at a higher speed; return the throttle control stick to the bottom; there will be a beep sound heard and the power light keeps flashing which means that the remote controller is sending out connectional signal. It will take about 10 seconds to finish the signal connection process. Once signal connection is completed, the power light will stay "on" without blinking and the remote controller is set for flight.

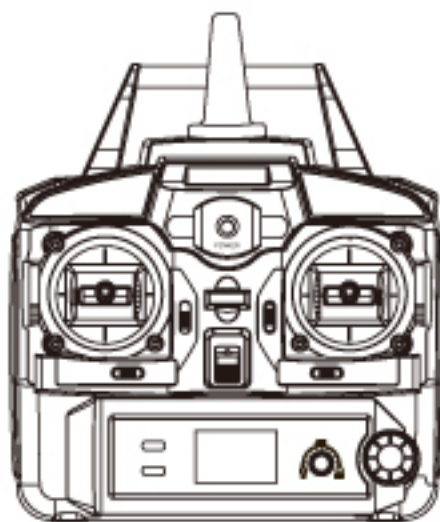

Pic.23

The model

- Make sure that the battery (at the bottom of the model) is well installed and connected with power wire of model. The model is OFF.
- Turn on the model; the flash light will keep flashing quickly, the gyro of the model will be in signal detecting condition. Set the model to flat surface, about 4 seconds later, the flash light will keep constant "ON". It means that signal connection is finished and the model is ready for flight.



Pic.24

- To ensure steady flight, please set the value of the Trimmer to the midpoint.
- Push up the throttle stick slowly and the model takes off.
- To avoid any misunderstanding, we have defined the orientation of the model as follows: The model is set to be copter nose right ahead and tail facing the player. The copter nose direction is named as "forward", the tail direction is named as "backward". The copter flies up to the sky is named as "upward"; the copter flies down to the ground is named as "downward". Player's left side is named as "left", player's right side is named as "right". All the directions we are talking about in this manual are subject to the definition above.

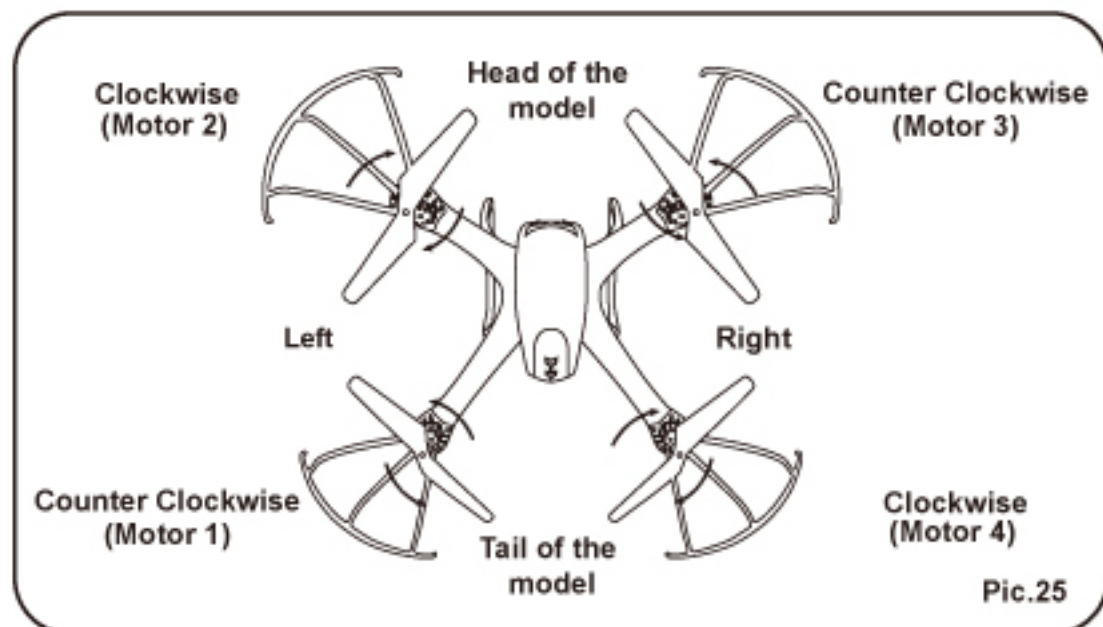

Pic.25

- The orange lights are at the front of the model; the blue lights are at the back of the model.
- Check the rotation direction of the rotor blades which is shown as. (Pic.25)
- If the model keeps flying to one side, it can be corrected by adjusting the trimmer on the remote control.



Remarks:

- Signal connection between the model and the remote control is required for the first use.
- Set the connection one by one to avoid signal connection error.
- To better protect the battery, please unplug the battery cable from the power wire after the use.

Trimmer Functions

- 1.If the model keeps moving forward/backward even there is no control signal given, users may adjust the elevator trim to keep the model balanced.

STICK MODE 1 or 3:

	<p>If the model keeps moving forward, push down Trimmer A until it gains balance.</p>
	<p>If the model keeps moving backward, push up Trimmer A until it gains balance.</p>

STICK MODE 2 or 4:

	<p>If the model keeps moving forward, push down Trimmer D until it gains balance.</p>
---	---



If the model keeps moving backward, push up Trimmer D until it gains balance.

2. If the model keeps moving leftward/rightward even there is no control signal given, users may adjust the aileron trim to keep the model balanced.

STICK MODE 3 or 4:



If the model keeps moving leftward, turn right of Trimmer B until it gains balance.



If the model keeps moving rightward, turn left of Trimmer B until it gains balance.

STICK MODE 1 or 2:

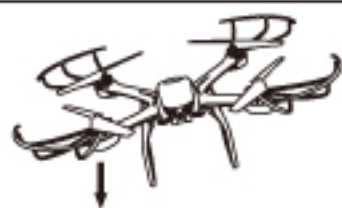



If the model keeps moving leftward, turn right of Trimmer C until it gains balance.





If the model keeps moving rightward, turn left of Trimmer C until it gains balance.

3. If the model keeps spinning even there is no control signal given, users may adjust the rudder trim to keep the model balanced.



STICK MODE 1 or 2:





	If the model keeps spinning counter clockwise in the air, turn right of Trimmer B until it gains balance.
	If the model keeps spinning clockwise in the air, turn left of Trimmer B until it gains balance.

STICK MODE 3 or 4:

	If the model keeps spinning counter clockwise in the air, turn right of Trimmer C until it gains balance.
	If the model keeps spinning clockwise in the air, turn left of Trimmer C until it gains balance.

Operating

Upward		Push up the throttle control stick, the rotation speeds of the mains rotors are increasing and the model ascends accordingly.
Downward		Push down the throttle control stick, the rotation speeds of the mains rotors are decreasing and the model descends accordingly.
Turn left		Turn the left/right turning control stick to the left, the model will turn left.

Turn right		Turn the left/right turning control stick to the right,the model will turn right.
Forward		When the model is flying, push up the forward/backward control stick, the model will move forward.
Backward		When the model is flying, push down the forward/backward control stick, the model will move backward.
Leftward flight		Turn the sideward flight control stick to the left side,the model will fly leftward.
Rightward flight		Turn the sideward flight control stick to the right side,the model will fly rightward.

3D Roll

There are 3 channels of the remote control: low speed channel, medium speed channel and high speed channel. At any channel, press the roll button on top of the remote control, the model will roll forward or roll backward accordingly. When the remote control is at high speed channel, roll action can be done through controlling the forward/backward control stick and the leftward/rightward flight control stick.

Manual Roll(at high speed channel):

When both of the left and right control stick travels are more than 95%, roll action will be performed once; when both of the left and right control stick travels are less than 95%, the model will perform the flight according to the received control signal.

One key Roll (at any channel):

To easily enjoy the fun of rolling, player can press the one key roll button to perform roll action. Before rolling, make sure that the model is flying 3 meters above the ground; then, press the one key roll button, the model will roll forward or backward according to the given signal.

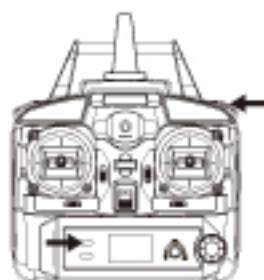

Pic.26

TIPS:

1. Beginners are recommended to play the model at low speed or medium speed channel.
2. It is better to play the model at open and wide space.

Headless mode:

Enter into headless mode:

Once signal of the model and the remote control is successfully connected, press the function button located at top right of the remote control for 2 seconds, the remote control will send out two beep sounds and there will be letters of "stick mod" flashing on the LCD screen, the model's indicator light turns from constant "ON" to "flashing". That means the model is in headless mode.

Exit headless mode:

When the model is in headless mode, press the function button at top right of the remote control of 2 seconds, the remote control will send out 2 beep sounds and the letter "Stick mod" is keeping constant "on"; the model's indicator light turns from flashing to constant "on". That means the model has exited the headless mode.



Pic.27

Check up on the direction of the model in headless mode :

When the model is in headless mode, flight direction proof is needed.

Set the head of the model ahead of the player, turn both of two control sticks to the lower right corner for about 2 seconds, the model's indicator light will turn from slowly flashing to quick flashing and flight direction proof is finished.



Pic.28



Pic.29

Flight direction control in headless mode:

- When checking up on the flight direction of the model, set the model nose right ahead and tail facing the player's, at this time, the model's nose is pointing forward; this direction will be constantly considered as "forward" when forward signal is given from the remote control, no matter where the model nose is pointing to. That is to say, the player's straight front side is defined as "forward"; the player's back side is defined as "backward", the player's left side is defined as left; the player's right side is defined as right.
- When the model is flying in headless mode, player should keep facing the forward direction. Otherwise, the model will be out of control. The model control is showed as below:

<p>Push up the forward/backward control stick, the model will fly forward, away from player.</p>		<p>Turn right the sideward flight control stick, the model will fly to the right side of the player.</p>
<p>Push down the forward/backward control stick, the model will fly backward, towards player.</p>		<p>Turn right the turning control stick; the model will turn to the left side of the player.</p>
<p>Turn left the sideward flight control stick; the model will fly to the left side of the player.</p>		<p>Turn left the turning control stick; the model will turn to the right side of the player.</p>

Remarks:

- Flight direction proof is needed when the model is going to fly in headless mode. When checking up on the flight direction, the model should be set right ahead and tail facing the player; the player should face the direction where the model nose is pointing to. Player should stand in the same direction when playing the model.
- When the model is flying in headless mode, if the flight direction is inconsistent with the player's operating direction or there's direction deviation, please stop playing and carry out the flight direction proof action again.

One key return:

When the model is flying in headless mode, press one key return button, the model will fly towards player. Press the one key return button again or operate the forward /backward control stick, the model will exit the one key return function.

FPV camera #C4005/#C4008/#C4010 installation (not included in the package)

Installed with #C4005/#C4008/#C4010 camera, the model can take photos and videos, if download and install the FPV software to the smart phone, FPV real-time transmission can be achieved through the connection of the model and the smart phone.

Install the holder of the mobile phone:



Pic.30

1.Connect the stand bar to the mobile phone fixing component.



Pic.31

2.Adjust the fixing component upward or downward according to the size of the mobile phone.



Pic.32

3.Set the mobile phone holder to the top of the remote control.

Remark:



Pic.33

1.Pull back the lock center of the stand bar and slowly push up the holder, the mobile phone holder would be taken down.

#C4005 installation:



Pic.34

1.The camera should be fastened to the interface at the bottom of the model.



Pic.35

2.Fix the camera by screwing clockwise.



Pic.36

3.Insert the camera wire plug to the camera interface.