

X-SERIES APP CONTROL FPV REAL-TIME

Wireless And High-Definition Video 6-Axis Gyro Quad-copter



INSTRUCTION MANUAL

Technical parameter of the model

Fuselage Length:310mm

Gross Weight: about 115g

Motor: Coreless motor

Overall Height: 58mm

Battery: Li-polymer 7.4V 350mAh

Main Rotor Diameter: 135mm

Charging Time: about 90 minutes

Introduction

- Quad-rotor design insures more stable and powerful performance and make all kinds of 3D action more easier.
- Headless mode and one key return are available.
- New designed structure makes assembly and maintenance easier.
- Adopting 2.4G auto connection technology, scores of model can be played at the same time.
- Equipped with the newest 6-axis gyro control system, this model has the characteristics of stable flight and easy operation.
- Full charged battery can support 9 minutes steady flight.
- New functions increased are altitude-hold mode, one key start/landing and mobile phone APP control.

Product/spare parts included in this packaging

Description	QTY (pc)	Description	QTY (pc)	Description	QTY (pc)
Model	1	Propeller	4	Screw	4
Remote Controller	1	Protecting Guard	1	Screwdriver	1
Manual	1	Mobile Phone Holder	1	USB charger	1

Thank you for purchasing this product. Please read this manual carefully before use and retain it for future reference.

Safety guidelines

- This product is not a toy. It is not applicable for children who are under 14 years old.
- Please read this instruction manual carefully before playing and operate the product according to the manual.
- The users are in full charge of proper operating the model. The manufacturer and dealers disclaim all responsibility for the damage caused by misuse.
- Keep the small accessories away from the kids to avoid accident.
- Keep batteries away from fire or high temperature environment.
- When flying the model, keep it 1~2 meters away from user or others to avoid injury due to collision.
- Not to decompose or modify the product which may cause malfunction or accident.
- Fly the model within your eye vision for easy and safety control.
- Need adult supervision when this model is being played by children.
- Only batteries of the same or equivalent type as recommended are to be used.
- Insert batteries with correct polarity.
- Non rechargeable batteries are not to be charged; the transmitter need 4 X AA batteries for work.
- Do not mix old and new batteries.
- Do not mix alkaline, standard(carbon-zinc), or rechargeable(nickel-cadmium) batteries.
- Rechargeable batteries are to be removed from the toy before being charged.
- Rechargeable batteries are only to be charged under adult supervision.
- Exhausted batteries are to be removed from the toy.
- The supply terminals are not to be short-circuited.
- The USB charging line to be used with the product should be regularly examined for potential hazard, such as damage to the cable or cord, plug, enclosure of other parts and that in the event of such damage, the product must not be used until that damage had been properly removed.

The LCD remote controller

Main features of the remote controller

- Adopt microcomputer control remote controller system and 2.4G auto connection technology, scores of copters can be played at the same time without any interference.
- Control the function of upward,downward,forward,backward, leftward,rightward,turn left, turn right and 3D flips & roll of the copter.
- Throttle control stick can be freely switched according to player's habit.

Sketch and function switches of the remote controller

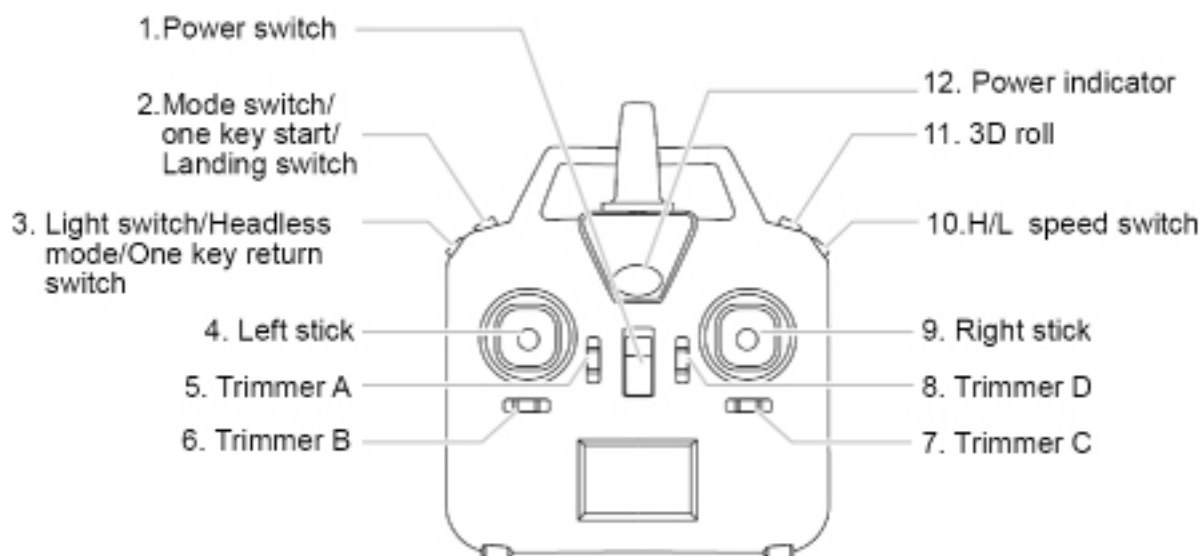

Remote Controller(Transmitter)

No.	Function switch	Function description
1	Power switch	It controls the power source of the transmitter.Slide the power switch to the "ON" position, the transmitter is powered on; slide the power switch to the "OFF" position, the transmitter is powered off.
2	Mode switch/One key start / Landing switch	1.Long-press to change the throttle control stick. 2.Short-press to start/land to the ground.

No.	Function switch	Function description
3	Light switch/ Headless mode/One key return switch	<p>1.This is the light switch of the model. Press it once to turn on the light and press it once again to turn off the light.</p> <p>2.Headless mode on-off button: Press this button for about 2 seconds, the remote control will send out 2 beep sounds and letters " stick mod" will be flashing on the LCD screen, the indicator light of the model turns from constant "on" to "flashing", then, the model is in the headless mode. Press this button again for about 2 seconds, the remote control will send out 2 beep sounds and "stick mod" keeps constant "on", indicator light of the model turns from flashing to constant "on", then, the model exit headless mode.</p> <p>3.When the model is flying in headless mode, press one key return button, the model will fly towards player. Press the one key return button again or operate the forward /backward control stick, the model will exit the one key return function.</p>
4	Left stick	<p>STICK MODE 2:upward/downward,turn left/turn right; STICK MODE 4:upward/downward,leftward/rightward. STICK MODE 1:forward/backward,turn left/turn right; STICK MODE 3:forward/backward,leftward/rightward.</p>
5	Trimmer A	<p>In stick Mode 2 and 4, this button is null. In stick Mode 1 and 3, it helps to tune the model's forward and backward flight.</p>
6	Trimmer B	<p>In stick Mode 3 and 4, it helps to tune the model's sideward flight. In stick Mode 1 and 2,it helps to tune the model's left and right direction turning speed.</p>
7	Trimmer C	<p>In stick Mode 3 and 4, it helps to tune the model's left and right direction turning speed. In stick Mode 1 and 2,it helps to tune the model's sideward flight.</p>
8	Trimmer D	<p>In stick Mode 1 and 3, this button is null. In stick Mode 2 and 4, it helps to tune the model's forward and backward flight.</p>

No.	Function switch	Function description
9	Right stick	STICK MODE 1: upward/downward, leftward/rightward; STICK MODE 3: upward/downward, turn left/turn right; STICK MODE 2: forward/backward, leftward/rightward; STICK MODE 4: forward/backward, turn left/turn right.
10	H/L speed switch	There are 2 flight modes of the model: low speed and high speed.
11	3D roll	Keep pressing the 3D rolling button and push the forward/backward and the leftward/rightward control stick to the edges to perform the roll actions accordingly.
12	Power indicator	The indicator light keeps blinking slowly: the transmitter is not activated. The indicator light keeps flashing rapidly: the transmitter is sending out connection signal to the model. The indicator light keeps on without blinking: the transmitter is ready for controlling the flight.

How to install the battery of remote controller

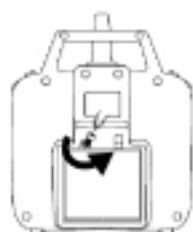

Pic.1

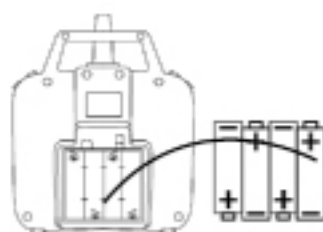

Pic.2



Pic.3

How to remove and insert batteries.

1. Unscrew counter clockwise to open the battery compartment cover. (Pic.1)
2. Install 4 X AA batteries into the battery compartment according to the given polarity. (Pic. 2)
3. Screw clockwise to close the battery compartment. (Pic. 3)

4 modes switches

Long-press the mode switch button to choose mode 2/ mode 4/
mode 1/mode 3.

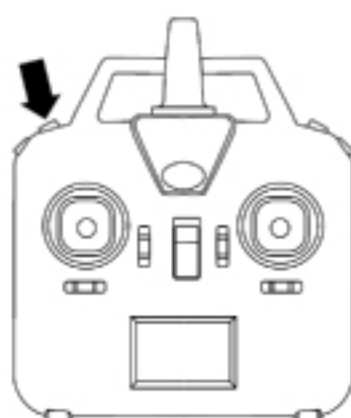

Stick mode selection

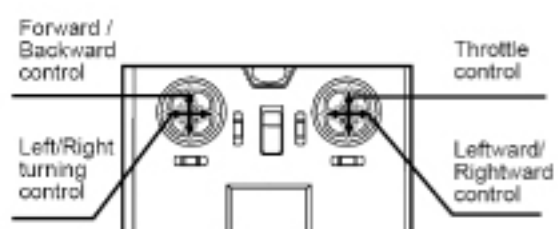

STICK MODE:1

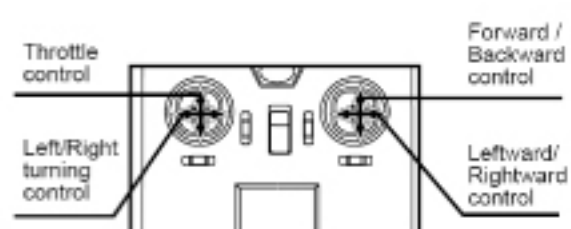

STICK MODE:2

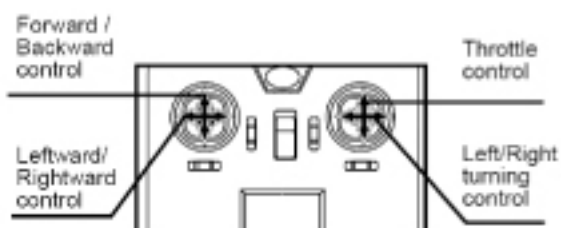

STICK MODE:3

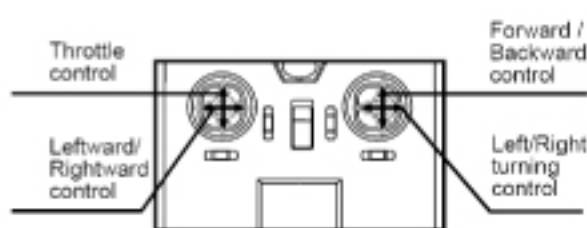

STICK MODE:4

Flight speed selection

There are 2 flight speeds available: low speed and high speed. Player can select the flight speed by pressing the H/L speed button.



The model

Major parts of the model

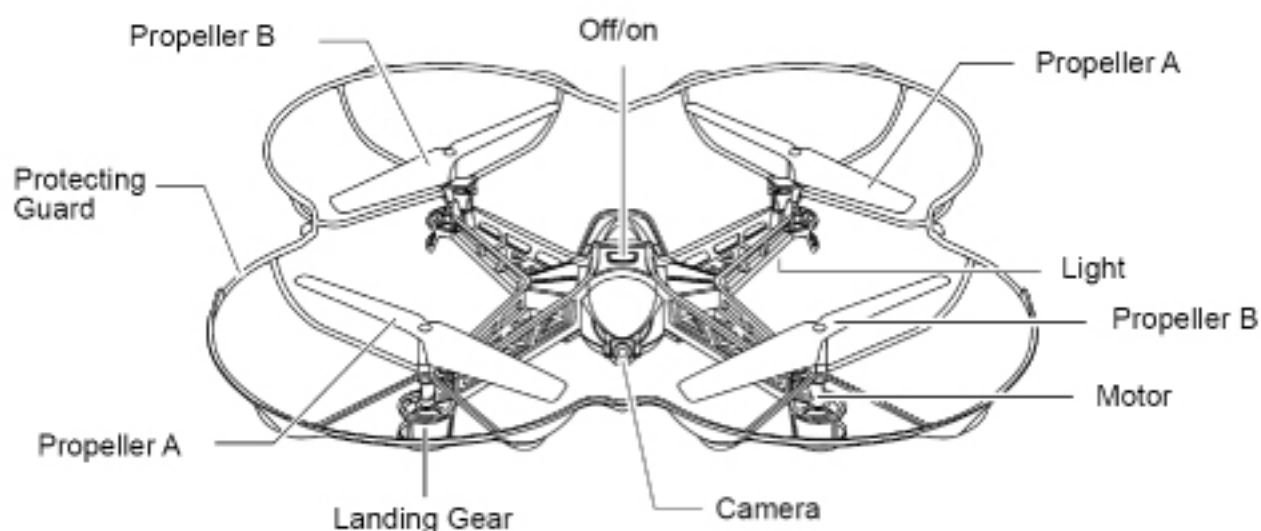

How to change new blades



Pic.4

1. Release the blades by screwing counter clockwise

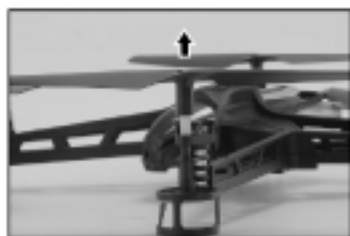

Pic.5

2.Remove the old blades,change new blades.



Pic.6

3.Fix the blades by screwing clockwise

How to change new battery for the model



Pic.7

1.Slide the power switch to "OFF".

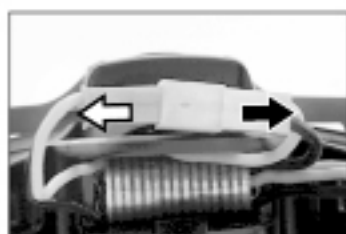

Pic.8

2. Unplug the battery wire from the power wire plug of the model .

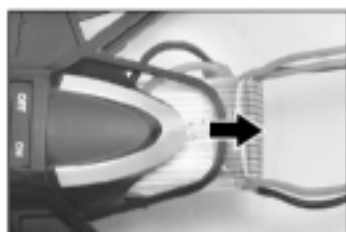

Pic.9

3.Take out the battery.

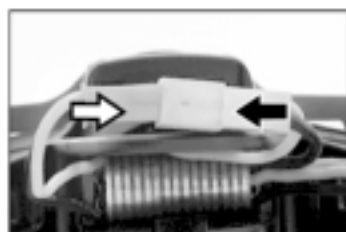

Pic.10

4.Plug the new battery wire into the power wire plug of the model and insert the battery into the battery compartment.

The method of the aircraft battery charging

Switch off the model. Unplug the battery cable from the power wire. Connect the the battery's trilinear wire plug with the USB wire plug, then, insert the USB interface to any USB applicable outlet for charging. While charging is proceeding, the USB is with red light on. Once the battery is full charged, the light will be off. Full charge takes about 90 minutes.

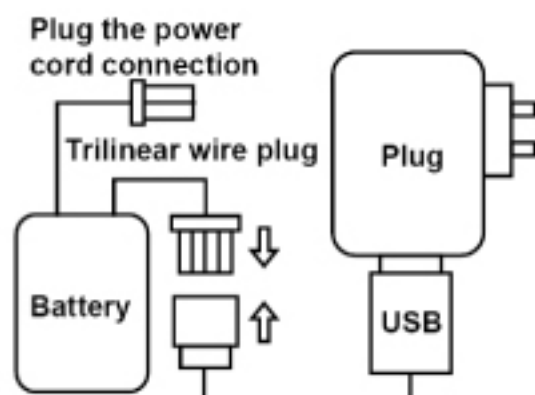

NOTE: Battery should be full charged before storing.

Preparation for flight

The remote control

- Recheck the playground; be sure that it is free from crowd, animals and other barrier.
- Turn on the remote controller and the power indicator light flashes rapidly and sends out connetional signal to the drone.
- Slide the throttle control stick up to the top; then, return the throttle control stick to the bottom; It will take about 10 seconds to finish the signal connection process. Once signal connection is completed, the power light will stay "on" without blinking and the remote controller is set for flight.

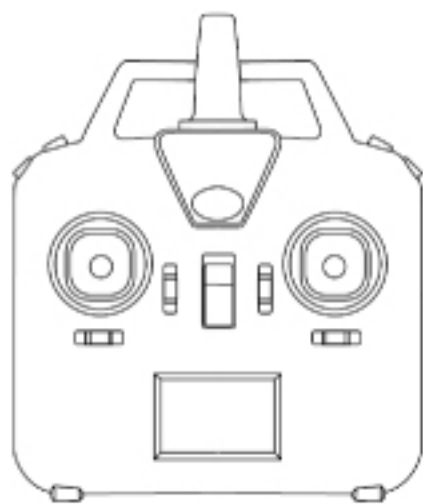

The model

- Make sure that the battery (at the bottom of the model) is well installed and connected with power wire of model. The model is OFF.
- Turn on the model; the flash light will keep flashing quickly, the gyro of the model will be in signal detecting condition. Set the model to flat surface, about 4 seconds later, the flash light will keep constant "ON". It means that signal connection is finished and the model is ready for flight.



- To ensure steady flight, please set the value of the Trimmer to the midpoint.
- Push up the throttle stick slowly and the model takes off.
- To avoid any misunderstanding, we have defined the orientation of the model as follows: The model is set to be copter nose right ahead and tail facing the player. The copter nose direction is named as "forward", the tail direction is named as "backward". The copter flies up to the sky is named as "upward"; the copter flies down to the ground is named as "downward". Player's left side is named as "left", player's right side is named as "right". All the directions we are talking about in this manual are subject to the definition above.

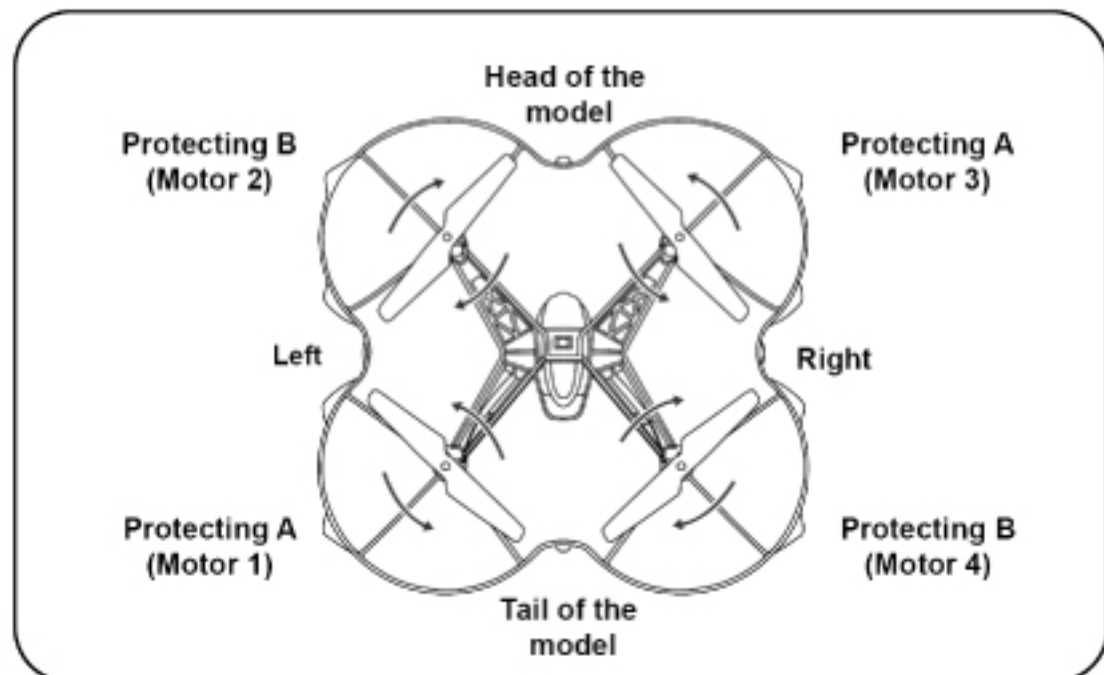

- The blue lights are at the front of the model; the orange lights are at the back of the model.
- When the model is on, checking the rotation direction of the rotor blades;the front-left and right-back rotor blades should be rotating in clockwise direction; the right-front and left-back rotor blades should be rotating in counter-clockwise direction.
- If the model keeps flying to one side, it can be corrected by adjusting the trimmer on the remote control.

Remarks:

- Signal connection between the model and the remote control is required for the first use.
- Set the connection one by one to avoid signal connection error.
- To better protect the battery, please unplug the battery cable from the power wire after use.

Trimmer functions

- 1.If the model keeps moving forward/backward even there is no control signal given, users may adjust the elevator trim to keep the model balanced.

STICK MODE 1 or 3:

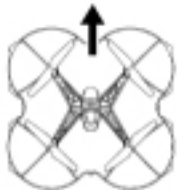
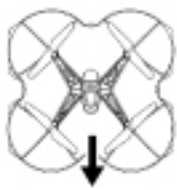

	<p>If the model keeps moving forward, push down Trimmer A until it gains balance.</p>
	<p>If the model keeps moving backward, push up Trimmer A until it gains balance.</p>

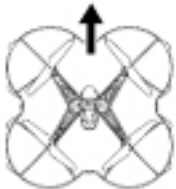
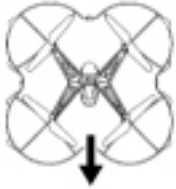
STICK MODE 2 or 4:



	If the model keeps moving forward, push down Trimmer D until it gains balance.
	If the model keeps moving backward, push up Trimmer D until it gains balance.

2. If the model keeps moving leftward/rightward even there is no control signal given, users may adjust the aileron trim to keep the model balanced.

STICK MODE 3 or 4:



	If the model keeps moving leftward, turn right of Trimmer B until it gains balance.
	If the model keeps moving rightward, turn left of Trimmer B until it gains balance.

STICK MODE 1 or 2:



	If the model keeps moving leftward, turn right of Trimmer C until it gains balance.
	If the model keeps moving rightward, turn left of Trimmer C until it gains balance.

3. If the model keeps spinning even there is no control signal given, users may adjust the rudder trim to keep the model balanced.

STICK MODE 1 or 2:

	<p>If the model keeps spinning counterclockwise in the air, turn right of Trimmer B until it gains balance.</p>
	<p>If the model keeps spinning clockwise in the air, turn left of Trimmer B until it gains balance.</p>

STICK MODE 3 or 4:

	<p>If the model keeps spinning counterclockwise in the air, turn right of Trimmer C until it gains balance.</p>
	<p>If the model keeps spinning clockwise in the air, turn left of Trimmer C until it gains balance.</p>

Operating

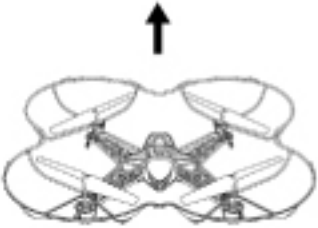
<p>Upward</p>		<p>Push up the throttle control stick, the rotation speeds of the mains rotors are increasing and the model ascends accordingly.</p>
<p>Altitude hold</p>	<p>Push up the throttle control stick, fly the drone to the expected height and release the throttle control stick. The drone will be hovering at this height.</p>	

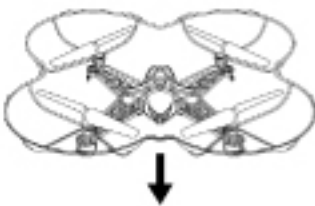
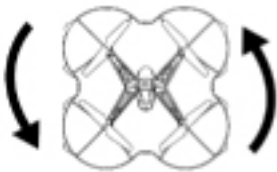
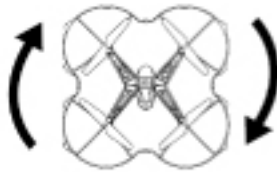
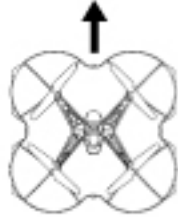
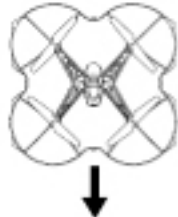
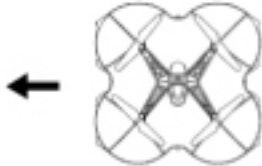
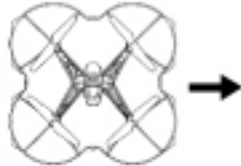
Downward		Push down the throttle control stick, the rotation speeds of the mains rotors are decreasing and the model descends accordingly.
Turn left		Turn the left/right turning control stick to the left, the model will turn left.
Turn right		Turn the left/right turning control stick to the right, the model will turn right.
Forward		When the model is flying, push up the forward/backward control stick, the model will move forward.
Backward		When the model is flying, push down the forward/backward control stick, the model will move backward.
Leftward flight		Turn the sideward flight control stick to the left side, the model will fly leftward.
Rightward flight		Turn the sideward flight control stick to the right side, the model will fly rightward.

Landing and emergency stop

Short-press the one key landing button or push the throttle control stick to make the drone gently land to the ground. About 2 seconds later, the drone will thoroughly stop flying.

When the drone is flying less than 1 meter height from the ground, but you need to stop the drone urgently. Please turn the left control stick of the remote control to the left-bottom and right control stick to the right-bottom to cease the flying drone.

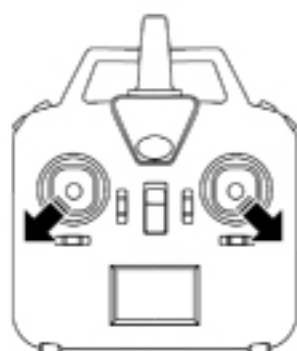

3D Roll

Keep pressing the 3D rolling button and push the forward/backward and the leftward/rightward control stick to the edges to perform the roll actions accordingly.

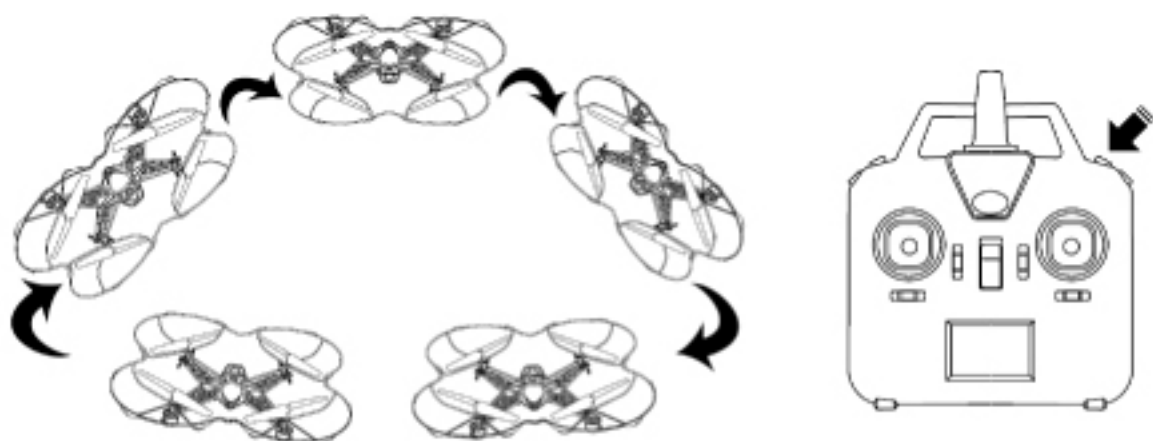

Notes:

We suggest beginner choosing non-obstacles space and soft ground for playing.

Headless mode:

Enter into headless mode:

Once signal between the model and the remote control is successfully connected, press the function button located at top right of the remote control for 2 seconds. The remote control will send out two beep sounds and there will be letters of “stick mod” flashing on the LCD screen, the model’s indicator light turns from constant ‘ON” to “flashing”. That means the model is in headless mode.

Exit headless mode:

When the model is in headless mode, press the function button at top left of the remote control for 2 seconds, the remote control will send out 3 beep sounds and the letter “Stick mod” is keeping constant “on”; the model’s indicator light turns from flashing to constant “on”. That means the model has exited the headless mode.

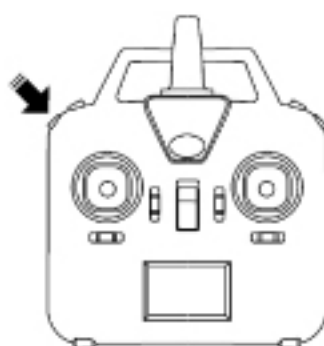

Check up on the direction of the model in headless mode:

When the model is in headless mode, flight direction proof is needed. Set the head of the model ahead of the player, turn both of two control sticks to the lower right corner for about 2 seconds, the model’s indicator light will turn from slowly flashing to quick flashing and flight direction proof is finished.

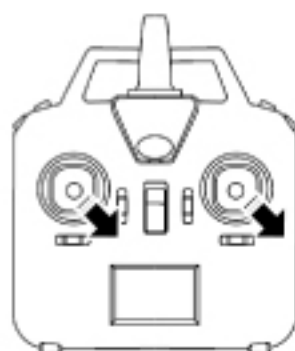

Flight direction control in headless mode:

- When checking up on the flight direction of the model, set the model nose right ahead and tail facing the player's, at this time, the model's nose is pointing forward; this direction will be constantly considered as "forward" when forward signal is given from the remote control, no matter where the model nose is pointing to. That is to say, the player's straight front side is defined as "forward"; the player's back side is defined as "backward", the player's left side is defined as left; the player's right side is defined as right.
- When the model is flying in headless mode, player should keep facing the forward direction. Otherwise, the model will be out of control. The model control is showed as below:

Push up the forward/backward control stick, the model will fly forward, away from player.		Turn right the sideward flight control stick, the model will fly to the right side of the player.
Push down the forward/backward control stick, the model will fly backward, towards player.		Turn right the turning control stick; the model will turn to the left side of the player.
Turn left the sideward flight control stick; the model will fly to the left side of player.		Turn left the turning control stick; the model will turn to the right side of the player.

One key return:

When the model is flying in headless mode, press one key return button, the model will fly towards player. Press the one key return button again or operate the forward /backward control stick, the model will exit the one key return function.

Remarks:

- Flight direction proof is needed when the model is going to fly in headless mode. When checking up on the flight direction, the model should be set right ahead and tail facing the player; the player should face the direction where the model nose is pointing to. Player should stand in the same direction when playing the model.
- When the model is flying in headless mode, if the flight direction is inconsistent with the player's operating direction or there's direction deviation, please stop playing and carry out the flight direction proof action again.

Barometer hold altitude

Once signal connection between the drone and the remote is finished, push up the throttle control stick to take off the drone. When the drone is flying more than 1 meter height, release the throttle stick. The drone will keep hovering at the current height.

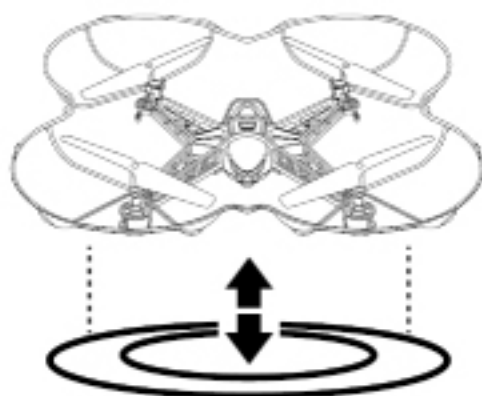

Remove/install the holder of the mobile phone:



Pic.11

- 1.Connect the stand bar to the mobile phone fixing component.



Pic.12

- 2.Adjust the fixing component upward or downward according to the size of the mobile phone.



Pic.13

3.Set the mobile phone holder to the top of the remote control.



Pic.14

4.Pull back the lock center of the stand bar and slowly push up the holder, the mobilephone holder would be taken down.

Install and remove the protection frame:



Pic.15

1.Install the protection frame:Thoroughly buckle the snap-ring of the protection frame to the snap-ring interface.



Pic.16

2.Remove the protection frame: Pull out the snap-ring from the snap-ring position with moderate force.

FPV real-time transmission software download, installation and function introduction.

Install software

- Mount camera on the drone and install the “MJX H” software to smart phone, the photos and videos that taking by the camera can be seen alive when the model is flying.

- For Android system, please visit our website www.mjxrc.com to download the software “MJX H”.
- For Apple IOS system, please go to the APP store to download the software “MJX H”.

There are two modes of the “MJX H ”APP

•Real-time images transmission mode



Pic.17

1.Open the software “MJX H”.



Pic.18

2.Click the“MONITOR” button.



Pic.19

3. Real-time image is showing on the screen.

•Mobile phone APP control mode



Pic.20

1.Open the software “MJX H”.



Pic.21

2.Click the“CONTROL” button.

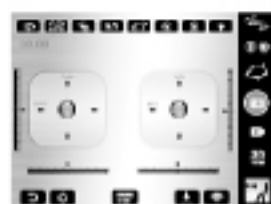

Pic.22

3.Activate the mobile phone APP real-time remote control interface.

Mobile phone APP "MJX H" control functions introduction

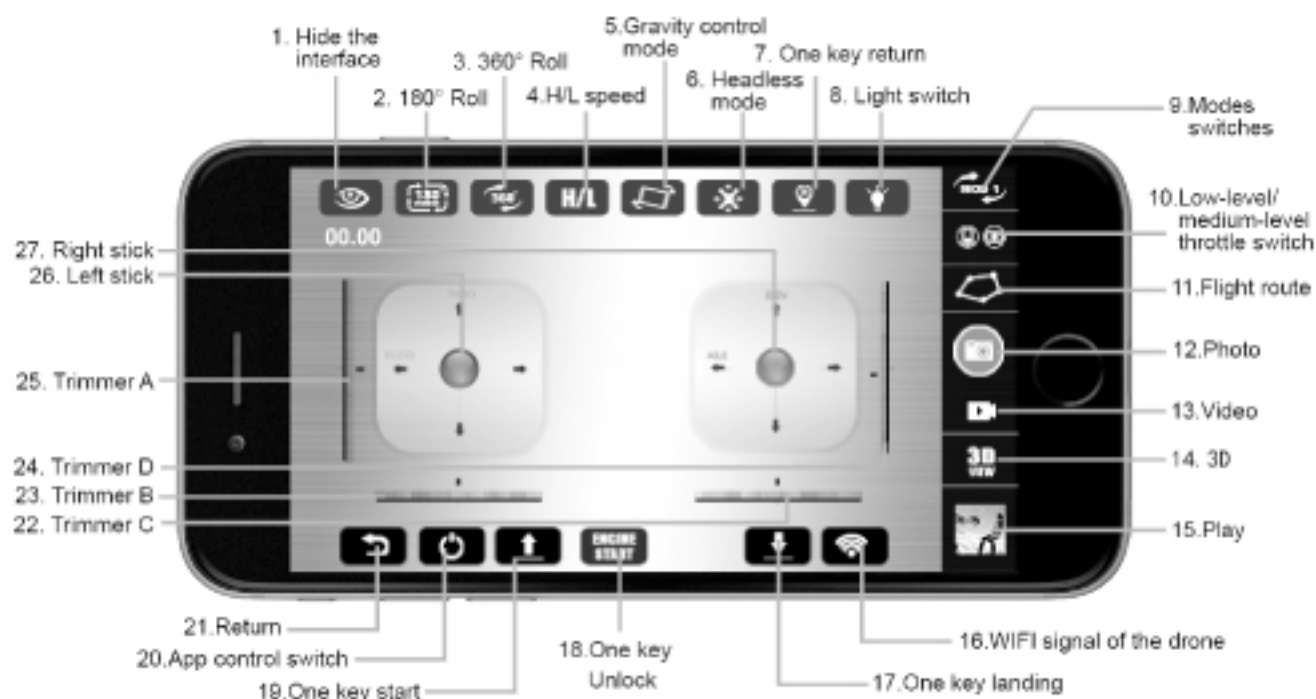

No.	Function switch	Function description
1	Hide the interface	Touch this button to hide the menu of the interface.
2	180° Roll	Touch this button to rotate the image 180-degree.
3	360° Roll	Once the drone is flying in the sky, touch this button the drone will 360 degree roll forward.
4	H/L speed	Turn on the APP control and then touch this button to enter into high and low speed choosing mode. When the H/L logo is in red color, the drone is in high speed mode; when the H/L logo is in black color, the drone is in low speed mode.
5	Gravity control mode	Touch this button to enter into the operation interface. MOD 2: The left control stick is the throttle control and left/right turning stick. The right stick is the forward/backward flight and leftward/rightward flight stick. MOD 1: The left control stick is the forward/backward control and left/right turning stick. The right stick is the throttle control and leftward/rightward flight stick. MOD 3: The left control stick is the forward/backward control and leftward/rightward flight stick. The right stick is the throttle control and leftward/rightward flight stick. MOD 4: The left control stick is the throttle control and leftward/rightward flight stick. The right stick is the forward/backward flight and left/right turning stick.

No.	Function switch	Function description
6	Headless mode	Turn on the remote control. Touch this icon to enter into headless mode and adjust the drone.
7	One key return	Touch this icon while the drone is in headless mode. The drone will return with rear heading back.
8	Light switch	Touch this button to turn on or turn off the light.
9	Modes switches	<p>The 4 modes are as below:</p> <p>MOD 2: The left control stick is the throttle control and left/right turning stick. The right stick is the forward/backward flight and leftward/rightward flight stick.</p> <p>MOD 1: The left control stick is the forward/backward control and left/right turning stick. The right stick is the throttle control and leftward/rightward flight stick.</p> <p>MOD 3: The left control stick is the forward/backward control and leftward/rightward flight stick. The right stick is the throttle control and leftward/rightward flight stick.</p> <p>MOD 4: The left control stick is the throttle control and leftward/rightward flight stick. The right stick is the forward/backward flight and left/right turning stick.</p>
10	Low-level/medium-level throttle switch	Low-level throttle is for drones without altitude hold mode playing. Medium-level throttle is for drones with altitude hold mode playing.
11	Flight route	<p>Turn on the APP control, and then touch here to enter into flight plan. The left stick is the throttle control stick; the right control stick is the left and right turning control stick. Touch the stick to control the flight.</p> <p>The blank space of the screen is for flight route drawing. Once the route is draw out, the drone will fly forward, backward, leftward and rightward according to the indication of the route.</p> 
12	Photo	Touch here, the camera will take photo.
13	Video	Touch here, the camera will take video.

No.	Function switch	Function description
14	3D	Touch here and wear the 3D VR glasses to experience the 3D effects.
15	Play	Touch here to play the saved video.
16	WIFI signal of the drone	It indicates the strength of the WIFI signal.
17	One key landing	While the drone is flying, touch here to gently land the drone.
18	One key unlock	Short press this button to unlock the drone when the drone is not unlocked.
19	One key start	Once the model is unlocked and rotates slowly on the ground. Short press this button, the model will take off automatically.
20	App control switch	Touch this button, the icon will be in red color while the mobile phone is sending out connection signal. Once the drone's WIFI signal is successfully connected, the drone indicate will be constant "on".
21	Return	Touch here to exit the APP control interface and enter into mode choosing.
22	Trimmer C	In stick Mode 3 and 4, it helps to tune the model's left and right direction turning speed. In stick Mode 1 and 2, it helps to tune the model's sideward flight.
23	Trimmer B	In stick Mode 3 and 4, it helps to tune the model's sideward flight. In stick Mode 1 and 2, it helps to tune the model's left and right direction turning speed.
24	Trimmer D	In stick Mode 1 and 3, this button is null. In stick Mode 2 and 4, it helps to tune the model's forward and backward flight.
25	Trimmer A	In stick Mode 2 and 4, this button is null. In stick Mode 1 and 3, it helps to tune the model's forward and backward flight.

No.	Function switch	Function description
26	Left stick	STICK MODE 2:upward/downward,turn left/turn right; STICK MODE 4:upward/downward,leftward/rightward. STICK MODE 1:forward/backward,turn left/turn right; STICK MODE 3:forward/backward,leftward/rightward.
27	Right stick	STICK MODE 1: upward/downward,leftward/rightward; STICK MODE 3: upward/downward, turn left/turn right; STICK MODE 2: forward/backward,leftward/rightward; STICK MODE 4: forward/backward,turn left/turn right.

Instructions on how to take off the drone by mobile phone APP control

Check and make sure that the camera is correctly mounted on the drone; and then connect the battery wire with the power plug of the receiver PCB. Turn on the drone, the LED light of the drone will flash quickly and the drone is in the gyro detection state. Set the drone to the flat position; enter into settings of the mobile phone. Open WIFI; then, search the WIFI signal "MJX H ****" from the WIFI signal list and connect the signal. Exit setting once the mobile phone is connected with "MJX H ****". Open the APP "MJX H" at the mobile phone; click "MONITOR" to enter into real-time images transmission interface to shoot. Click "CONTROL" to enter into the APP control interface. Touch the APP control icon. The icon will be in red color while the mobile phone WIFI is sending out connectional signal. Once the mobile phone's WIFI signal is successfully connected with the drone's WIFI signal, the drone indicator light will be in constant "on". Touch the one key start icon, the drone will rotate in low speed. At this time, push up the throttle control stick icon, the drone will take off.



Turn on and turn off the APP control



Start switch



Landing switch

How to stop the APP mobile phone control in emergency case and how to correct the gyro

Short-press the one key landing button or push the throttle control stick to make the drone gently land to the ground.

About 2 seconds later, the drone will thoroughly stop flying. When the drone is flying less than 1 meter height from the ground, but you need to stop the drone urgently, please turn the left control stick of the remote control to the left-bottom and right control stick to the right-bottom to cease the flying drone.



Correction of the gyro

When the model is in headless mode, flight direction proof is needed. Set the head of the model ahead of the player, turn both of two control sticks to the lower right corner for about 2 seconds, the model's indicator light will turn from slowly flashing to quick flashing and flight direction proof is finished.



Accessories(Optional)



301H01
Main Frame

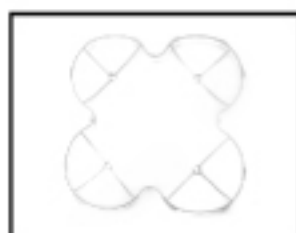

301H02
Protecting Guard



301H03
Lower Cover/
Battery Compartment/
Motor Pressboard/
Battery Slide Sheet

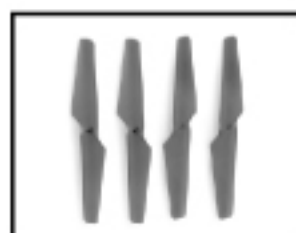

301H04
Propeller A/B



301H05
Clockwise Motor



301H06
Counter Clockwise Motor



301H07
**Steel Tube/iron Shaft/
Glue Hexagonal /
Motor Gear/gear**



301H08
Receiver PCB



301H09
Camera Board



301H10
Screws Pack



301H50
Manual



301H51
Color Box



301H52
Inner Blister



401H12
Battery



401H13
Usb Charging Cable

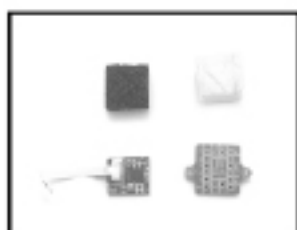

401H14
**Altitude Hold
PCB Component**



GR302
Remote Controller

Trouble shooting

	phenomenon	reason	solution
1	The lights are flashing quickly.	Gyro of the model is under signal detecting condition.	Set the model to any flat surface.

	phenomenon	reason	solution
2	The lights are flashing on twice and flashing off once.	The model is not received the signal from the remote control or signal connection is interrupted.	For absence of signal, activate the remote control for the signal connection. For signal interruption, turn off the remote control and turn it on again.
3	The lights are flashing on and off.	The model is underpowered.	Charge the battery or change another full charged battery.
4	The model is shaking fiercely.	The rotor blade is out of shape.	Change the rotor blades.

Note: a) Changes or modifications not expressly approved by the party responsible for compliance could void the user's authority to operate the equipment.

b) This equipment has been tested and found to comply with the limits for a Class B digital device, pursuant to part 15 of the FCC Rules. These limits are designed to provide reasonable protection against harmful interference in a residential installation. This equipment generates, uses and can radiate radio frequency energy and, if not installed and used in accordance with the instructions, may cause harmful interference to radio communications. However, there is no guarantee that interference will not occur in a particular installation. If this equipment does cause harmful interference to radio or television reception, which can be determined by turning the equipment off and on, the user is encouraged to try to correct the interference by one or more of the following measures:

- Reorient or relocate the receiving antenna.
- Increase the separation between the equipment and receiver.
- Connect the equipment into an outlet on a circuit different from that to which the receiver is connected.
- Consult the dealer or an experienced radio/TV technician for help.

